

Legend	图例
	SC Vanity Sink Cut-out (Undermount) 开台下安装洗脸盆孔并磨边
	FH Faucet Holes 开水龙头出水孔
	TC Toilet Tissue Cut Out 开纸卷槽孔—不磨边
	FS Facial Slot Cut-out 开面巾槽—磨边并倒角
	KC Kitchen Sink Cut-out 开台下安装水槽盆孔并磨边
	RC Rough Cut No Chamfered 机切边—不倒角
	CE Rough Cut & Chamfered Edge 机切边—倒角
	EE Eased & Polished Edge 平边—轻微倒角
	BV Beveled Edge 斜边
	FB Full Bull Nose 圆边
	HB Half Bull nose 半圆边
	1/4R 1/4R Rounded Edge 1/4圆边
	DP Drip Less Edge 反水边
	OG Ogee Edge 鸭嘴边
	LM-FB Laminated Full Bull Nose Edge 加厚的圆边/牛鼻边
	LM-OG Laminated Ogee Edge 加厚的鸭嘴边
	LM-EE Laminated Eased & Polished Edge 加厚的平边
	LM-BV Laminated Beveled Edge 加厚的斜边

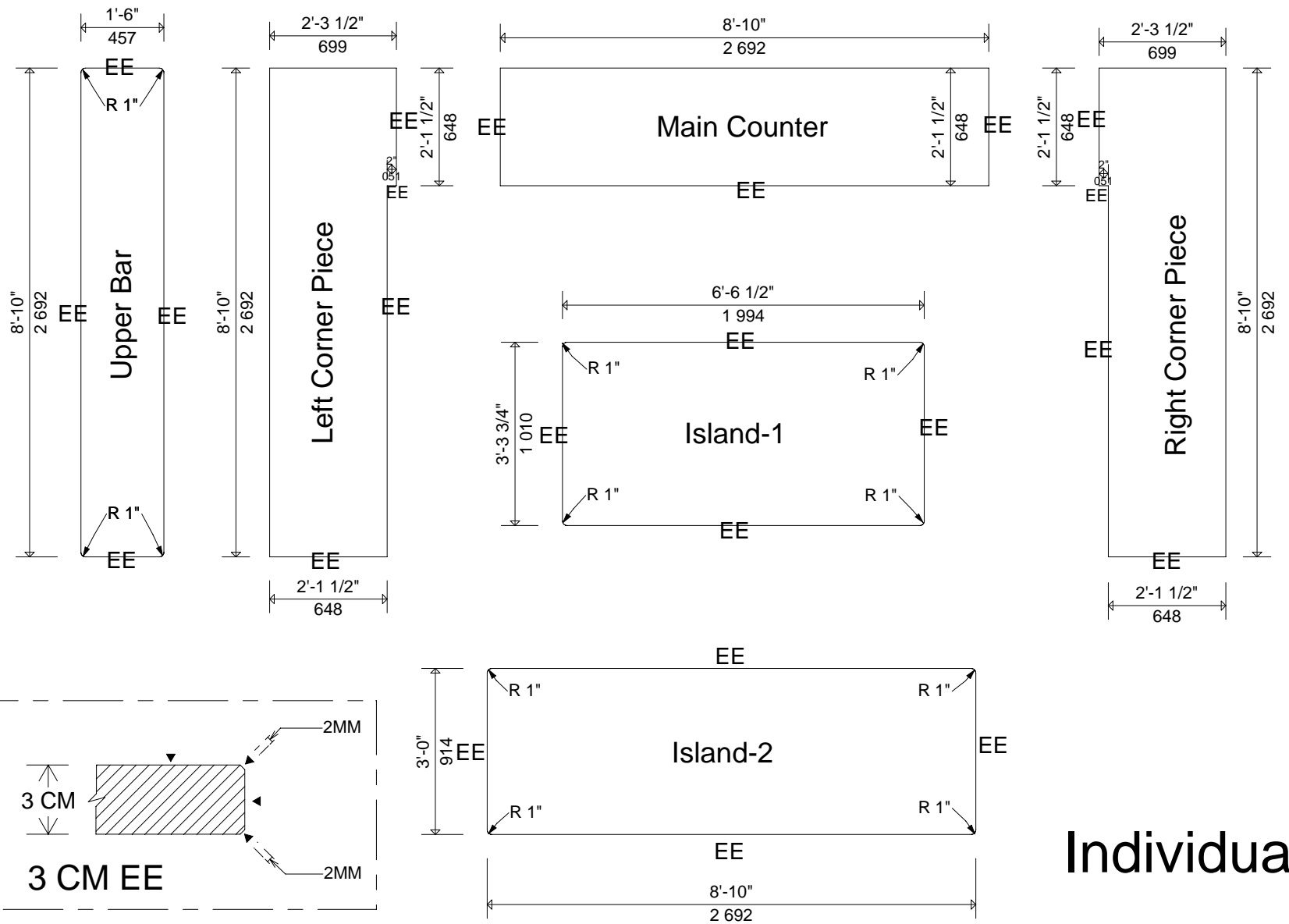







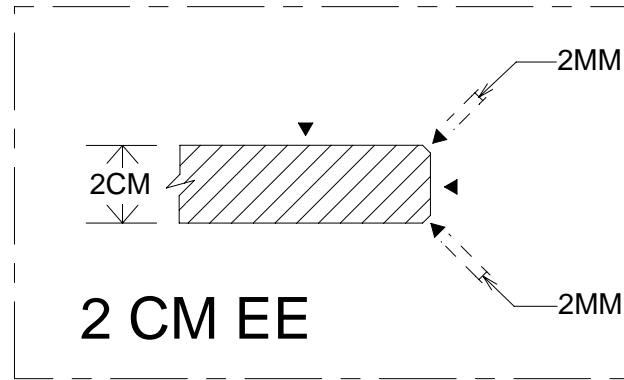
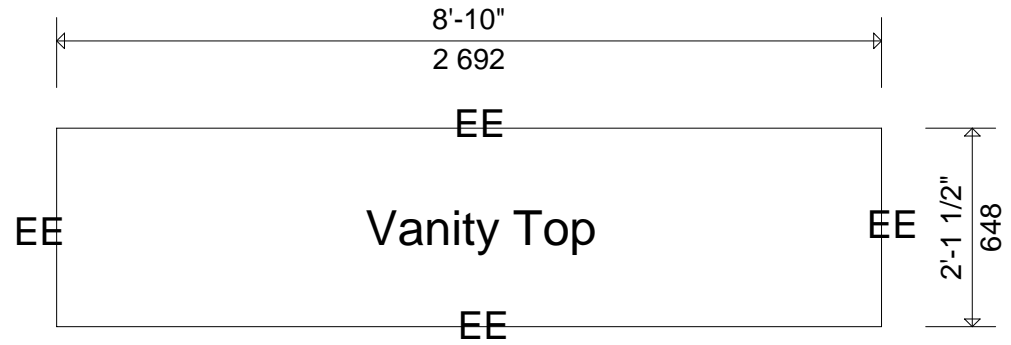



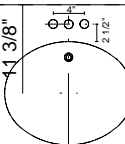

# Individual

Item #	Code#	Style	Add On	L	W	TK	Color	QTY	Granite Shop Drawing			
项目	产品/标识号	类型	加工	长	宽	厚	石种	数量	Client/客户	1580 Sawgrass Corporate Parkway Suite 130 Sunrise Florida 33323 Satellite office 954-255-3126 Corporate Office 954-315-4592 Fax 954-227-0287		
a1		Corner Piece (left)	EE	106	27 1/2	1 3/16			<b>Rococo Stone Inc</b> Project/项目	Drafter / 制图员 DWG# / 图号 <b>Counter Top &amp; Island System</b>		
a2		Main Counter	EE	106	25 1/2	1 3/16						
a3		Corner Piece (right)	EE	106	27 1/2	1 3/16						
a4		Upper Bar	EE	106	18	1 3/16						
a5		Island-1	EE	78 1/2	39 3/4	1 3/16						
a6		Island-2	EE	106	36	1 3/16						
									Rev. Date / 制图日期	SCALE/比例		

Legend	图例
	SC Vanity Sink Cut-out (Undermount) 开台下安装洗脸盆孔并磨边
	FH Faucet Holes 开水龙头出水孔
	TC Toilet Tissue Cut Out 开纸卷槽孔—不磨边
	FS Facial Slot Cut-out 开面巾槽—磨边并倒角
	KC Kitchen Sink Cut-out 开台下安装水槽盆孔并磨边
	RC Rough Cut No Chamfered 机切边—不倒角
	CE Rough Cut & Chamfered Edge 机切边—倒角
	EE Eased & Polished Edge 平边—轻微倒角
	BV Beveled Edge 斜边
	FB Full Bull Nose 圆边
	HB Half Bull nose 半圆边
	1/4R 1/4R Rounded Edge 1/4圆边
	DP Drip Less Edge 反水边
	OG Ogee Edge 鸭嘴边
	LM-FB Laminated Full Bull Nose Edge 加厚的圆边/牛鼻边
	LM-OG Laminated Ogee Edge 加厚的鸭嘴边
	LM-EE Laminated Eased & Polished Edge 加厚的平边
	LM-BV Laminated Beveled Edge 加厚的斜边

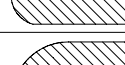
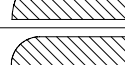
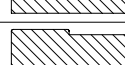
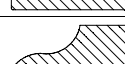

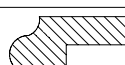
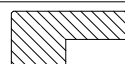
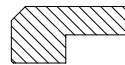
Item #	Code#	Style	Add On	L	W	TK	Color	QTY	Granite Shop Drawing			
项目	产品/标识号	类型	加工	长	宽	厚	石种	数量	Client/客户	1580 Sawgrass Corporate Parkway Suite 130 Sunrise Florida 33323 Satellite office 954-255-3126 Corporate Office 954-315-4592 Fax 954-227-0287		
a7		Vanity Top	EE	106	25 1/2	3/4				Rococo Stone Inc		
									Project/项目			
									Rev. Date / 制图日期	SCALE/比例	Drafter / 制图员	DWG# / 图号
												Multipurpose System

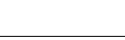
Legend	图例
	SC Vanity Sink Cut-out (Undermount) 开台下安装洗脸盆孔并磨边
	FH Faucet Holes 开水龙头出水孔
	TC Toilet Tissue Cut Out 开纸卷槽孔—不磨边
	FS Facial Slot Cut-out 开面巾槽—磨边并倒角
	KC Kitchen Sink Cut-out 开台下安装水槽盆孔并磨边
	RC Rough Cut No Chamfered 机切边—不倒角
	CE Rough Cut & Chamfered Edge 机切边—倒角
	EE Eased & Polished Edge 平边—轻微倒角
	BV Beveled Edge 斜边
	FB Full Bull Nose 圆边
	HB Half Bull nose 半圆边
	1/4R 1/4R Rounded Edge 1/4圆边
	DP Drip Less Edge 反水边
	OG Ogee Edge 鸭嘴边
	LM-FB Laminated Full Bull Nose Edge 加厚的圆边/牛鼻边
	LM-OG Laminated Ogee Edge 加厚的鸭嘴边
	LM-EE Laminated Eased & Polished Edge 加厚的平边
	LM-BV Laminated Beveled Edge 加厚的斜边

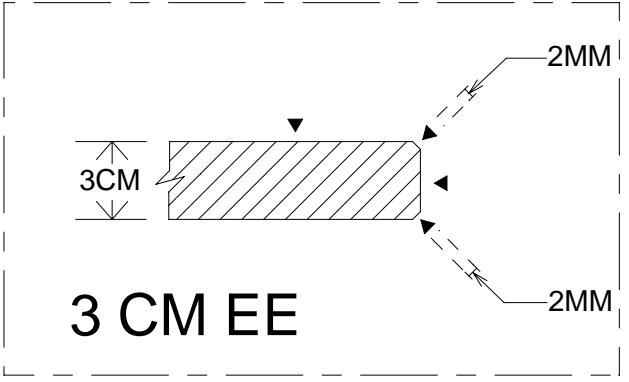
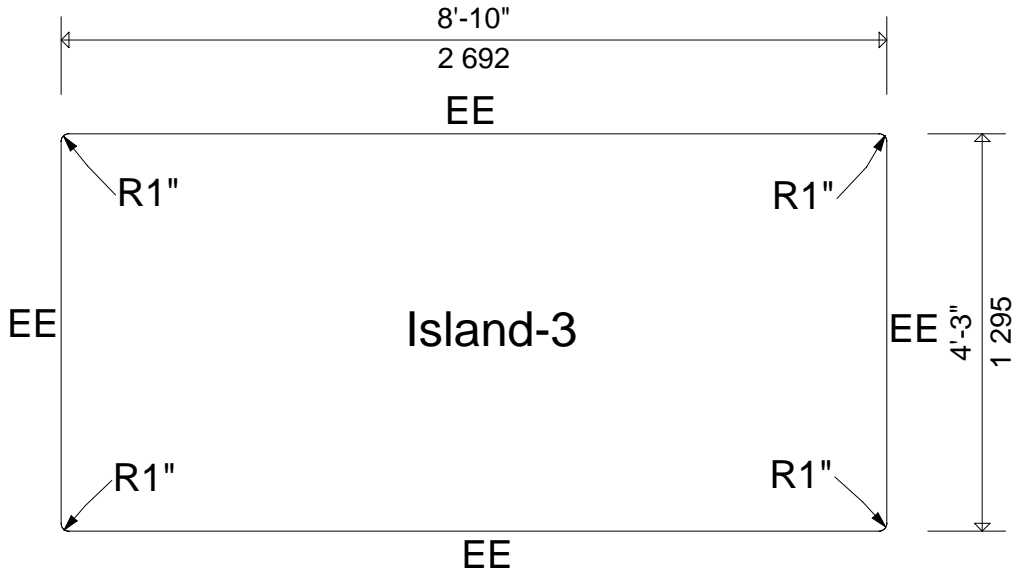

Item #	Code#	Style	Add On	L	W	TK	Color	QTY	Granite Shop Drawing			
项目	产品/标识号	类型	加工	长	宽	厚	石种	数量	Client/客户	1580 Sawgrass Corporate Parkway Suite 130 Sunrise Florida 33323 Satellite office 954-255-3126 Corporate Office 954-315-4592 Fax 954-227-0287		
a8		Island-3	EE	106	51	1 3/16			Rococo Stone Inc			
									Project/项目			
									Rev. Date / 制图日期	SCALE/比例	Drafter / 制图员	DWG#/ 图号
												Multipurpose System

Legend	图例
	SC Vanity Sink Cut-out (Undermount) 开台下安装洗脸盆孔并磨边
	FH Faucet Holes 开水龙头出水孔
	TC Toilet Tissue Cut Out 开纸卷槽孔—不磨边
	FS Facial Slot Cut-out 开面巾槽—磨边并倒角
	KC Kitchen Sink Cut-out 开台下安装水槽盆孔并磨边
	RC Rough Cut No Chamfered 机切边—不倒角
	CE Rough Cut & Chamfered Edge 机切边—倒角
	EE Eased & Polished Edge 平边—轻微倒角
	BV Beveled Edge 斜边
	FB Full Bull Nose 圆边
	HB Half Bull nose 半圆边
	1/4R 1/4R Rounded Edge 1/4圆边
	DP Drip Less Edge 反水边
	OG Ogee Edge 鸭嘴边
	LM-FB Laminated Full Bull Nose Edge 加厚的圆边/牛鼻边
	LM-OG Laminated Ogee Edge 加厚的鸭嘴边
	LM-EE Laminated Eased & Polished Edge 加厚的平边
	LM-BV Laminated Beveled Edge 加厚的斜边

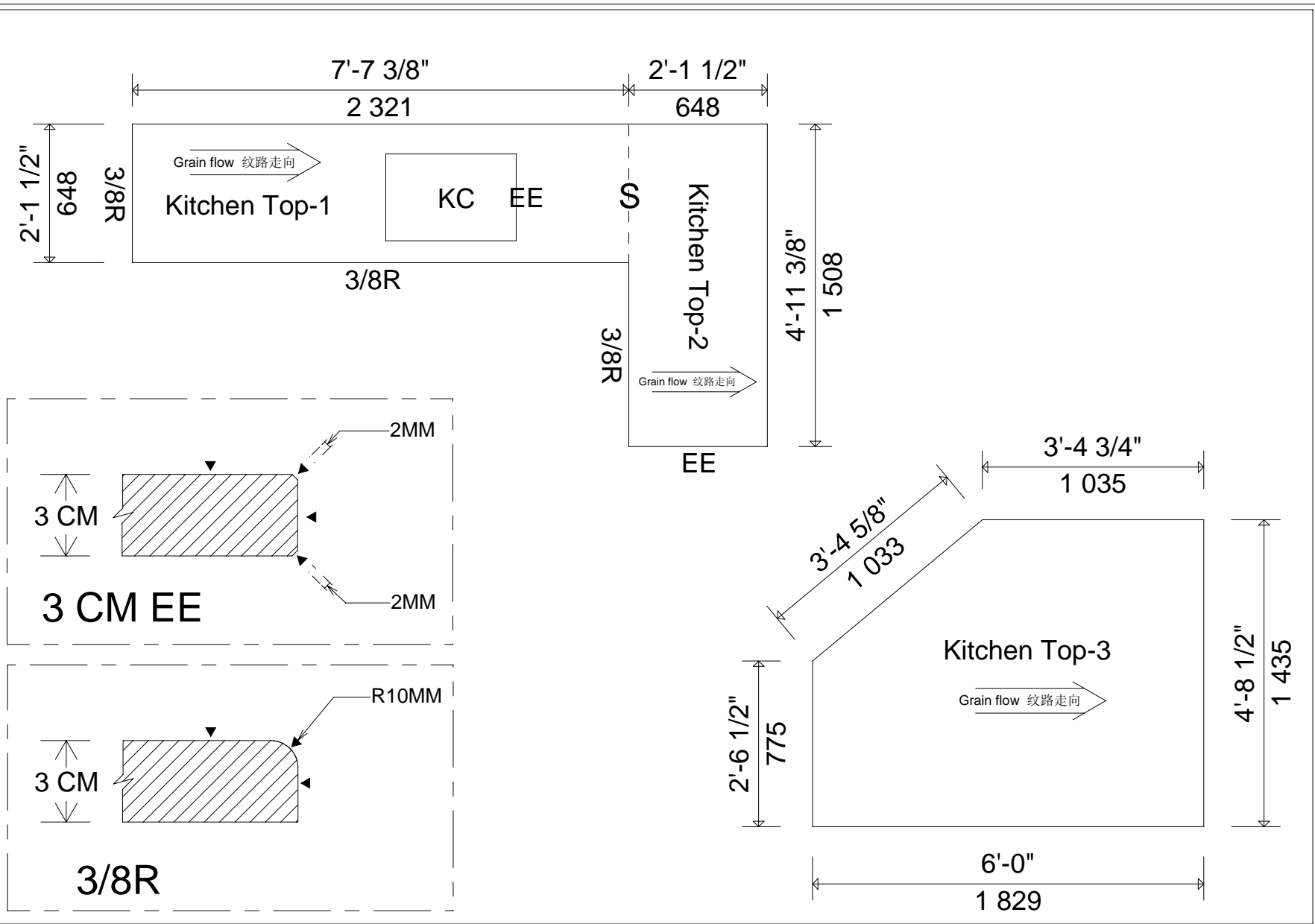

Item #	Code#	Style	Add On	L	W	TK	Color	QTY	Granite Shop Drawing			
项目	产品/标识号	类型	加工	长	宽	厚	石种	数量	Client/客户	Rococo Stone Traders Logo		
f1		Kitchen Top-1	3/8R,1-KC	91 3/8	25 1/2	1 3/16	Santa Cecelia	1	Rococo Stone Inc	1580 Sawgrass Corporate Parkway Suite 130 Sunrise Florida 33323 Satellite office 954-255-3126 Corporate Office 954-315-4592 Fax 954-227-0287		
f2		Kitchen Top-2	3/8R,EE	25 1/2	59 3/8	1 3/16	Santa Cecelia	1				
f3		Kitchen Top-3	CO	72	56 1/2	1 3/16	Santa Cecelia	1				
									Project/项目			
									Rev. Date / 制图日期	SCALE/比例	Drafter / 制图员	DWG# / 图号
									Kitchen			